

JSB394 IO Circuit Detail

Typical User Connection

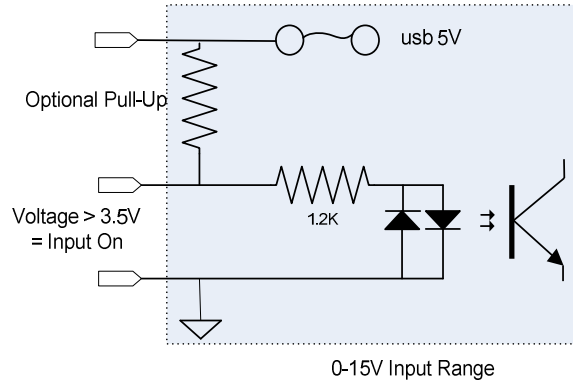

**Input
not isolated**

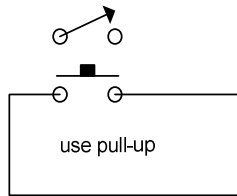
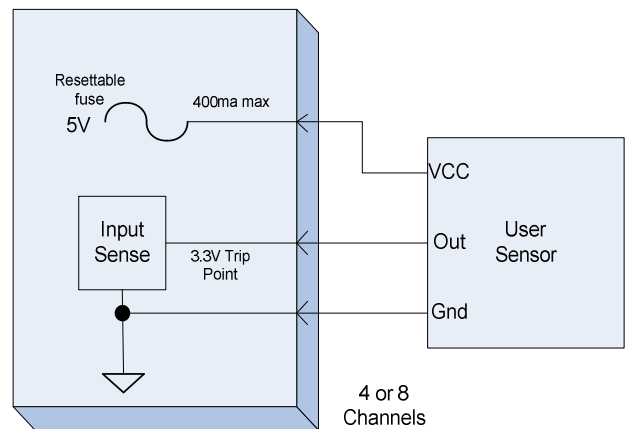
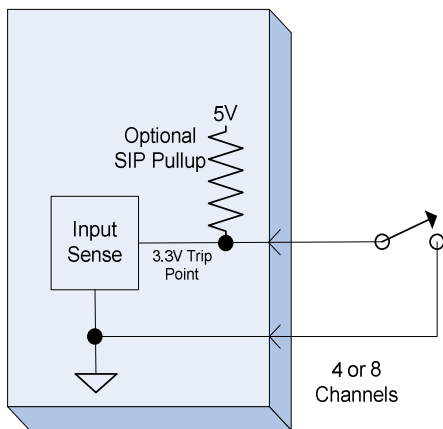
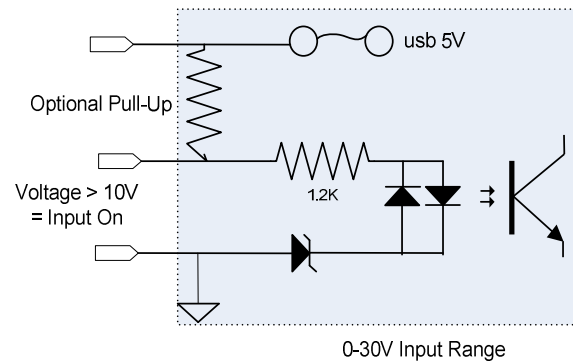
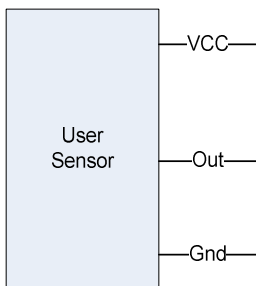

Sample Connections